

LS-L50

A Commuter Category Transport Airship

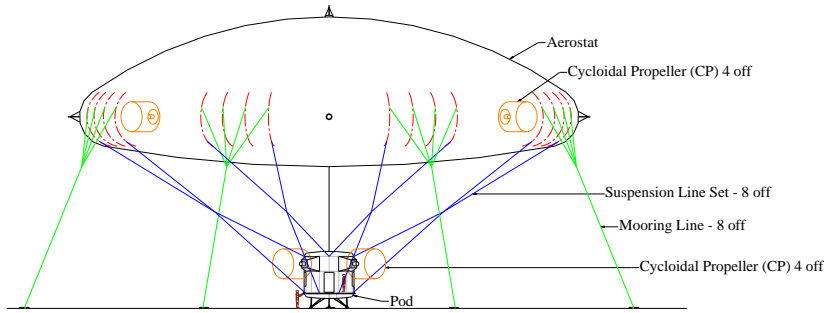

High Moored Arrangement at Mean Sea Level (MSL)

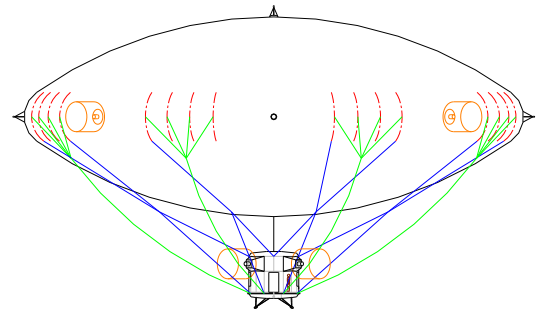

Aerial Arrangement at 2500 m above MSL

Key Aspects:

- An omni-directional dirigible buoyant aircraft for operation like helicopters (always upright)
- Low drag variable geometry lenticular (discus form) aerostat enabling aero-static/dynamic lift
- Quiet operation, also able to fly routinely as a silent steady un-powered free balloon
- Stable 24 hour endurance that is environmentally friendly (low emissions)
- 6 degree of freedom control with 2 sets of quad cycloidal propellers
- VTOL style manned (piloted) operation – balloon/airship and helicopter style control methods
- Doesn't need aerodynamic stabilisers, elevators or rudders – controlled with thrust
- Fixed when moored and able to be cloaked at low level for storm endurance
- Compact (smaller than unidirectional airships) & able to access small sites almost anywhere
- A resilient airship, able to operate in normal weather that most aircraft also would fly in
- Assembled and maintained outdoors without a hangar, although protection is recommended
- Designed for setup and operation at/from small cleared level sites without a mast or runway

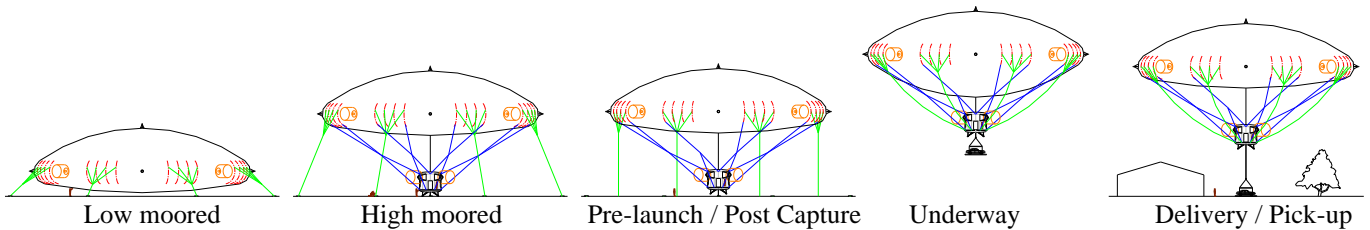

Duties: designed for ad-hoc aerial crane duties (enabling construction) and cargo transport almost anywhere with under-slung loads up to 5 tonne (5000 kg), as illustrated right. Alternatively, it may be configured for long endurance aerial duties with systems to suit as a:

- Patroller for aerial survey – persistent ISR presence over wide areas, including marine & arctic regions
- Rescue vehicle; able to hold station over a ground position with little downdraft
- Disaster relief aid aircraft; humanitarian search, assist, medical & supplies (food, equipment, shelters)
- Aerial cruiser for tourism and commuter flights in otherwise difficult to access regions

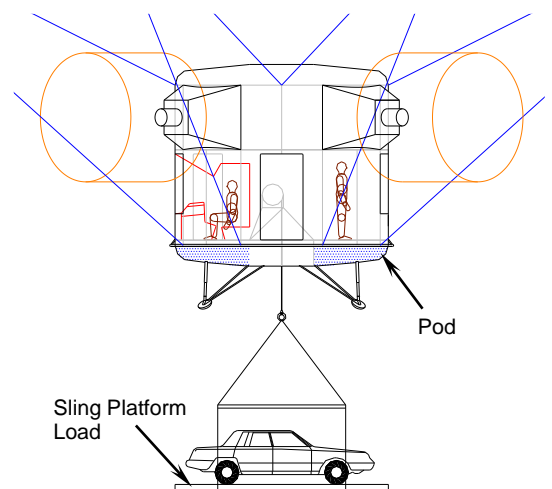

Instead, it may be used to transport light standardised payload units (PUs), typically as illustrated right, for general freight haulage – able to pick up and deliver them without grounding (pseudo landing) & little support.

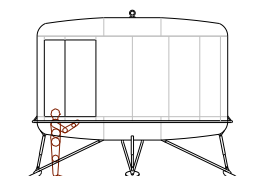

Note: LTA aircraft normally don't land but can be readily ground restrained.

LS-L50

A Commuter Category Transport Airship



General specification:

Gas fill / Overall aerostat volume	15,000 m ³ (529,720 ft ³) / 20,000 m ³ (706,290 ft ³)
Aerostat maximum diameter	50 m (164 ft)
Aerostat height at sea level / pressure altitude	15 m (49.2 ft) / 20 m (65.6 ft)
Overall airship height	29.2 m (95.8 ft)
Disposable load / Payload	6,000 kg (13,228 lb) / 5,000 kg (11,023 lb)
Max and cruise airspeeds	50 Kn (92.6 km/h) and 40 Kn (74.1 km/h)
Max wind speed - launch/capture	20 Kn (37.0 km/h) gusting to 25 Kn (46.3 km/h)
Max wind speed - low moored	60 Kn (111.1 km/h)
Max wind speed - low moored & cloaked	80 Kn (148.2 km/h)
Cruise altitude	600 m (2000 ft) AMSL
Pressure altitude (ceiling)	2500 m (8200 ft) AMSL
Endurance - continuous cruise power	24 h at cruise airspeed
Endurance - un-powered	Unlimited
Range - continuous cruise power	1800 km (1118 mile)
Range - floating with wind	Unlimited
Power - max airspeed	447 kW (600 hp) Diesel producing electricity
Power - cruise airspeed	298 kW (400 hp)
Propulsion	Electrically driven cycloidal propellers

Notes: Following prototype production and shake down, confirmation of these estimates will be possible with likely improvements. The LS-L50 will be developed to remain within Commuter category certification requirements without needing to satisfy higher Large Aircraft standards.

The LS-L50 is a new lighter-than-air (LTA) technology way for an airship to fulfil needed aerial crane and general light freight transport duties, which may be in marine environments or remote regions with little infrastructure almost anywhere. It also has long endurance capability, where payload may be traded for customer systems with unbroken time on duty (several days). It provides a stable platform to carry sensitive payloads up to 5000 kg. A passenger variant is possible.

Operators may expect a practical, easily-maintained aircraft with relatively low acquisition and operating costs. It will allow them to expand their services and create new markets. Swappable pods will enable quick configuration changes; for example, from freighter to a geostationary electronic systems platform. The LS-L50 will be quick to set up and deploy (less than 12 hours out of the box), easy to manage on the ground (5 person setup, launch and moor), maintain and be operated by a single pilot plus 2 crew (relief pilot/crane operator and systems engineer for in-flight support) with low workload.

Storm protection

It's recommended that operators also acquire an annular skirt and a SkyDome for respectively away field and base maintenance severe weather protection, as shown left and right.

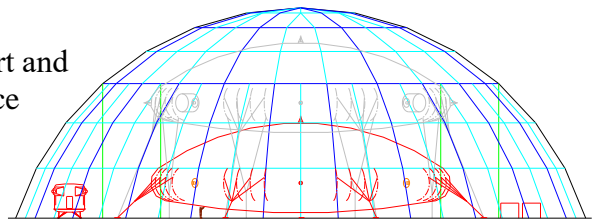
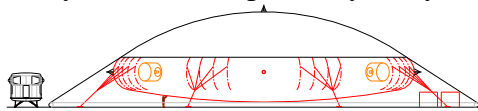

These are both compatible light temporary structures needing ballast or anchors instead of foundations to hold them. Launch/capture is vertical, directly from either base; obviating cross field ground movement. No runways, mast or swinging awkwardly in the breeze – just simple common sense!

Current status

The concept design is complete, ready for development. The project costs, timeline schedule, people and business plans have been scoped (documents available). It should be noted that there also are plans for smaller and larger types to suit a variety of purposes with a future goal to provide serious aerial cranes for say 150t payload (practically anything, anytime, anywhere), where this version prepares and enables the way for them – proving the technology and establishing infrastructure necessary for their operation.

Contact as below.